

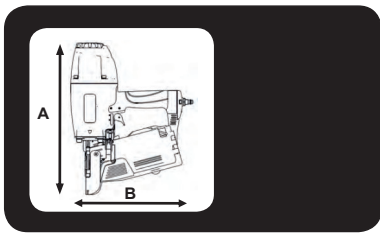

haubold®

RNC90Z





RNC90Z

		A = 414 mm B = 316 mm C = 136 mm
		= 3,45 kg

Min. 5,0 bar Max. 8,3
2,55 l (6 bar) /
Ps max. = 8,3 bar

EN 12549+EN ISO 4871 EN 12096: 1997 ISO 8662-11	L WA.1s = 100 dBA L pA.1s = 90 dBA L pA.1s1m = 87 dBA
	Vibration = 3,2 m/s²

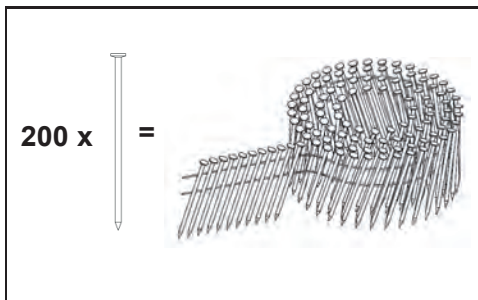

NAIL / COLLATION SPECIFICATION NAGEL / ANBINDUNG SPEZIFIKATION	
Welded-wire coil nails / Drahtgebundene Nägel	Plastic sheet coil nails / Plastikgebundene Nägel













+

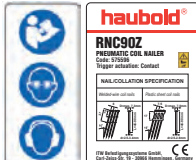

=



	<p>Sequential trigger actuation/ Einzelauslösung/ enkelschots/ Déclenchement du tir - mode séquentiel/ Funcionamiento secuencial "en continuo"/ Gatilho de actuação sequencial/ funcionamiento secuencial (colpo a colpo)/ Enkeltskuds aftrækker/ Enkeltskott/ Enkeltskudds avtrekker/ Kertalaukaisu/ Üksiklasu meetodil töötamine/ Uruchomienie spustu sekwencyjne/ Sekvenční spoušť/ Egyes lövés (szakaszosan működtetett elsütő billentyűvel)/ Posamezno proženje/ Kontaktirajte singl / Последовательная активация при нажатии на курок/ Sekvenčná aktivácia spúšte/ التشغيل بالتسلسل (المقيد) / Nuoseklusis paleidimo mechanizmas/ Sekvenciālās palaišanas iedarbināšana Račkovjejkuvirkjun</p>
	<p>Contact trigger actuation/ Kontaktauslösung/ repeterend schieten/ Déclenchement du tir - mode rafale/ Funcionamiento por contacto "clavo a clavo"/ Gatilho de actuação por contacto/ funcionamiento a contacto/ Stødskydning aftrækker/ Støtskjutning/ Støtspikrings avtrekker/ Kosketuslaukaisu/ Automaatmeetodil töötamine/ Uruchomienie spustu przez kontakt/ Kontaktní spoušť/ Sorozatlövés (folyamatosan behűzött elsütő billentyűvel)/ Kontaktno proženje/ Kontaktirajte pokretanje/ Контактная активация при нажатии на курок/ Kontaktná aktivácia spúšte/ التشغيل بتلامس الزر / Kontaktinis paleidimo mechanizmas/ Kontakta palaišanas iedarbināšana/ Snertikveijkuvirkjun</p>

<p>Model: RNC90Z No. 575595</p>  	<p>Model: RNC90Z No. 575596</p>  		
			
 			
<p>No. 014748 + No. 575600</p>	<p>No. 014121</p>		

Accessories

			
<p>No. 151299 / No. 576216</p>	<p>No. 574494</p>	<p>No. 575643</p>	<p>No. 617375</p>
<p>0,5 l oil / 1 l oil</p>	<p>Hanger</p>	<p>Flat Safety Lever</p>	<p>Flat Rubber Pad</p>

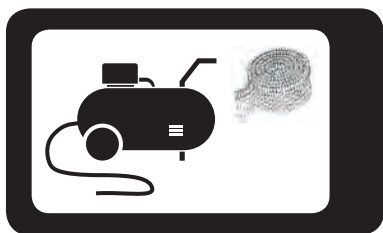

014 748

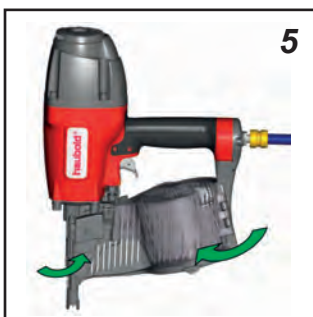
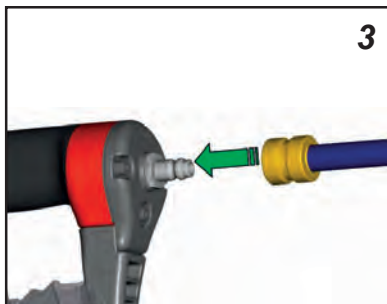
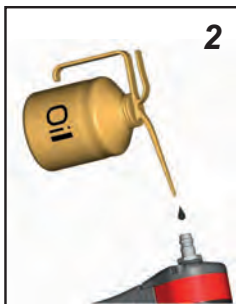
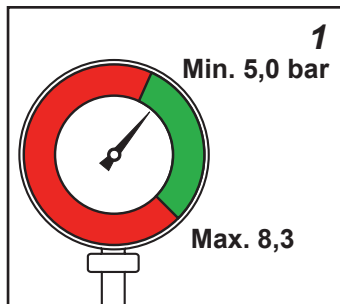

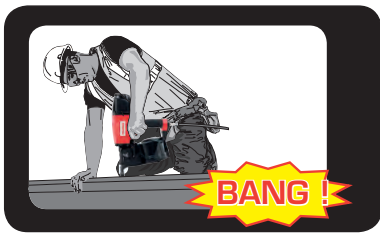

014 748



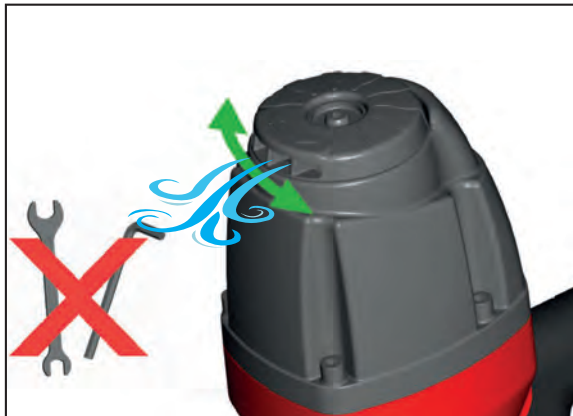
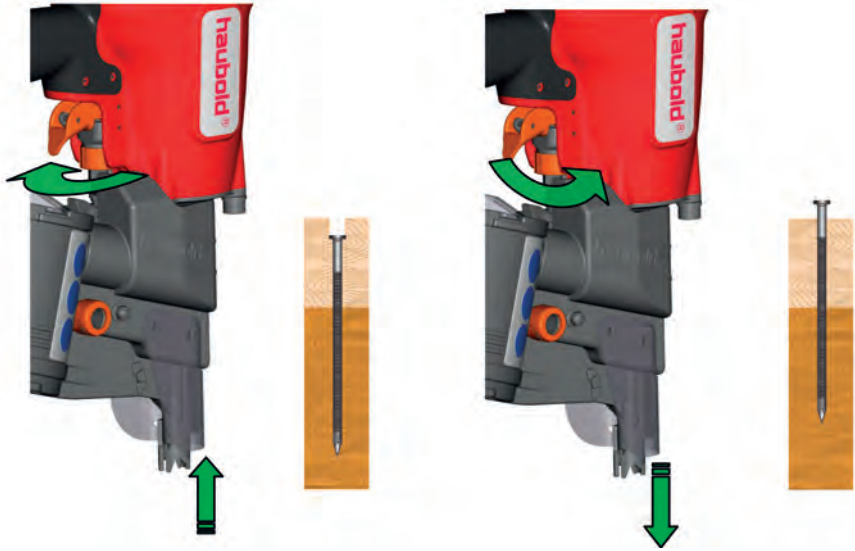
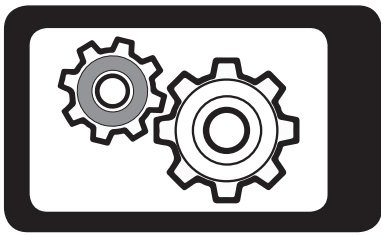

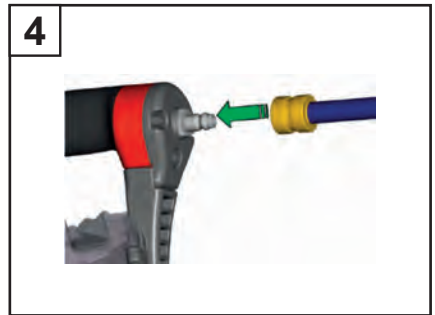
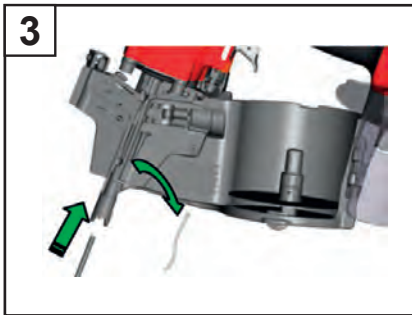
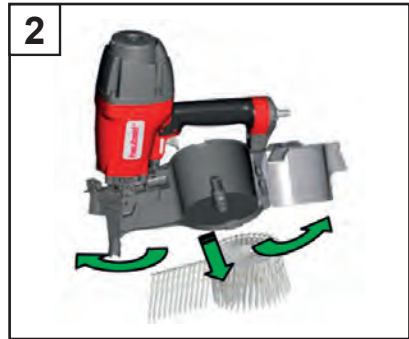
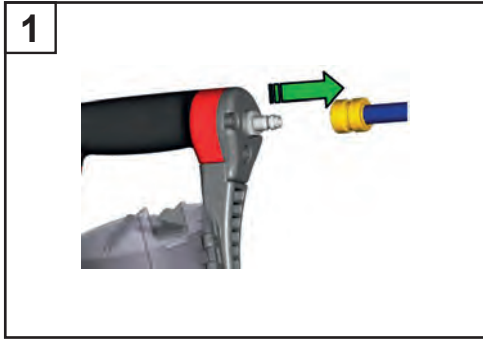

YY/WW....



YY= Year of manufacture
WW = Week of manufacture

**Resting position/ Ruheposition/ Position de repos/ Ruststand/
Posición de descanso/ Posizione di riposo/ Posição de des-
canso/ Pozycja spoczynku/ Klidová poloha/ Nyugalmi állapot/
Положение в нерабочем состоянии/ Θέση αδράνειας/ Hviles-
tilling/ Viloläge/ Hvileposisjon/ Lepoasento/ Položaj mirovanja/
Pokojuvá poloha/ Položaj mirovanja/ وضع السكون / Ramybės
padėtis/ Ooteasend/ Miera stāvoklis/ Hvíldarstaða**



haubold[®]

ITW CONSTRUCTION PRODUCTS EUROPE
Code 575600 (05/2019)
www.spitpaslode.com