

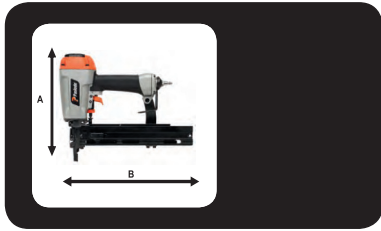

Paslode®





S200.2 S16

<p>A</p> <p>B</p>	<p>C</p>	<p>A = 297 mm</p> <p>B = 383 mm</p> <p>C = 86 mm</p>
		= 2,52 kg

<p>Min. 5,5 bar</p> <p>Max. 8,3 bar</p>
<p>1,2 l (6 bar) /</p>
<p>Ps max. = 8,3 bar</p>

<p>EN 12549+EN ISO 4871</p>	<p>L_{WA}, 1s, 1m = 95 dBA</p> <p>L_{pA}, 1s = 54 dBA</p> <p>L_{pA}, 1s, 1m = 82 dBA</p>
<p>EN 12096 : 1997</p> <p>ISO 8662 - 11</p>	<p>Vibration = 1,7 m/s²</p>

<p>150 x</p>		<p>Paslode Staples S16</p>
		<p>13 mm</p> <p>19-50 mm</p> <p>1.6x1.3 mm</p>







	<p>Contact trigger actuation/ Kontaktauslösung/ repeterend schieten/ Déclenchement du tir - mode rafale/ Funcionamiento por contacto "clavo a clavo"/ Gatilho de actuação por contacto/ funcionamiento a contacto/ Stødskydnings aftrækker/ Støtskjutning/ Støtspikrings avtrekker/ Kosketuslaukaisu/ Automaatmeetodil töötamine/ Uruchomienie spustu przez kontakt/ Kontaktní spoušť/ Sorozatlövés (folyamatosan behúzott eisütő billentyűvel)/ Kontaktno proženje/ Kontaktirajte pokretanje/ Контактная активация при нажатии на курок/ Kontaktná aktivácia spúšte/ التشغيل بتلامس الزر / Kontaktinis paleidimo mechanizmas/ Kontakta palaides iedarbināšana/ Snertikveikjувirkjun</p>
---	--

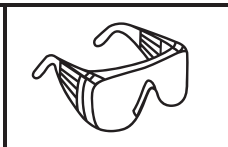

Model: S200.2 S16 Contact

No. 650415

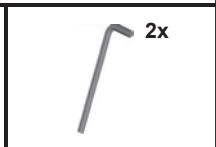

				
<p>No. 014748 + No. 577063</p>	<p>No. 014121</p>			

Accessories

	
<p>No. 151299 / No. 576216 0,5 l oil / 1 l oil</p>	

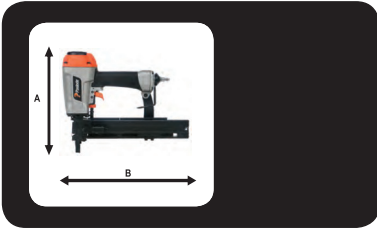

S200.2 W16

		A = 297 mm
		B = 383 mm
		C = 86 mm
		= 2,7 kg

<p>Min. 5,5 bar Max. 8,3 bar</p>
<p>1,1 l (6 bar) / </p>
<p>Ps max. = 8,3 bar</p>

<p>EN 12549+EN ISO 4871</p>	<p>L_{wA}, 1s, 1m = 95 dBA L_{pA}, 1s = 54 dBA L_{pA}, 1s, 1m = 82 dBA</p>
<p>EN 12096 : 1997</p> <p>ISO 8662 - 11</p>	<p>Vibration = 1,9 m/s²</p>

<p>150 x </p>		<p>Paslode Staples W16</p>	<p>23.3 mm</p> <p>16-50 mm 1.6x1.4 mm</p>
---------------	--	--------------------------------	---





Contact trigger actuation/ Kontaktauslösung/ repeterend schieten/ Déclenchement du tir - mode rafale/ Funcionamiento por contacto "clavo a clavo"/ Gatilho de actuação por contacto/ funcionamiento a contacto/ Støtskjytnings aftrækker/ Støtskjytning/ Støtspikrings avtrekker/ Kosketuslaukaisu/ Automaatmeetodil töötamine/ Uruchomienie spustu przez kontakt/ Kontaktní spoušť/ Sorozatlövés (folyamatosan behúzott elsütő billentyűvel)/ Kontaktno proženje/ Kontaktirajte pokretanje/ Контактная активация при нажатии на курок/ Kontaktná aktivácia spúšte/ التشغيل بتلامس الزر / Kontaktinis paleidimo mechanizmas/ Kontakta palaides iedarbināšana/ Snertikveikjувirkjun

Model: S200.2 W16 Contact

No. 650416

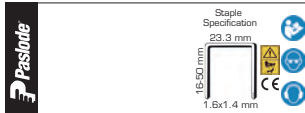

No. 014748 + No. 577063



No. 014121



2x

Accessories

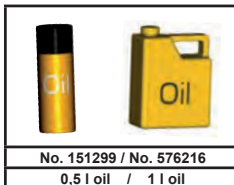

No. 151299 / No. 576216

0,5 l oil / 1 l oil

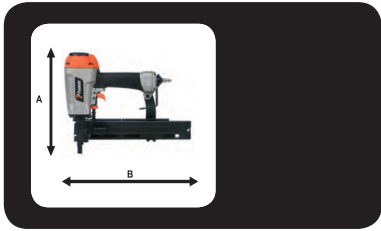

S200.2 ZH16

		A = 297 mm
		B = 383 mm
		C = 86 mm
		= 2,7 kg

<p>Min. 5,5 bar Max. 8,3 bar</p>
<p>1,1 l (6 bar) / </p>
<p>Ps max. = 8,3 bar</p>

<p>EN 12549+EN ISO 4871</p>	<p>L_{WA}, 1s, 1m = 95 dBA L_{pA}, 1s = 54 dBA L_{pA}, 1s, 1m = 82 dBA</p>
<p>EN 12096 : 1997</p> <p>ISO 8662 - 11</p>	<p>Vibration = 1,9 m/s²</p>

<p>110 x </p>		<p>22.9 mm</p>
<p>Paslode Staples ZH16</p>	<p>25-45 mm</p> <p>1.25x2.20 mm</p>	



EN ISO 11148-13
International
Safety
Standard

	<p>Sequential trigger actuation/ Einzelauslösung/ enkelschots/ Déclenchement du tir - mode séquentiel/ Funcionamiento secuencial "en continuo"/ Gatilho de actuação sequencial/ funzionamento sequenziale (colpo a colpo)/ Enkeltskudds aftrækker/ Enkelskott/ Enkeltskudds avtrekker/ Kertalaukaisu/ Úksiklasu meetodil töötamine/ Uruchomienie spustu sekwencyjne/ Sekvenční spoušť/ Egyes lövés (szakaszosan működtetett elsütő billentyűvel)/ Posamezno proženje/ Kontaktirajte singl / Последовательная активация при нажатии на курок/ Sekvenčná aktivácia spúšte/ التشغيل بالزر التسلسلي المقفول) Nuoseklusis paleidimo mechanizmas/ Sekvenčiālās palaišanas iedarbināšana Raðkveikjuvirkjun</p>
---	--

Model: S200.2 ZH16 Sequential
No. 577070





Staple Specification





22.9 mm

25-45 mm

1.25x2.20 mm





				 2x
No. 014748 + No. 577063		No. 014121		

Accessories



No. 151299 / No. 576216

0,5 l oil / 1 l oil

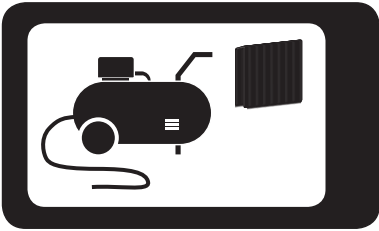

014 748

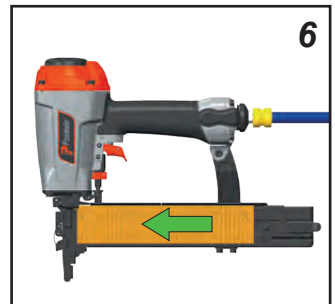
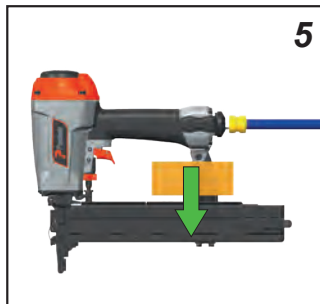
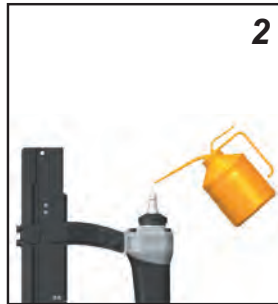
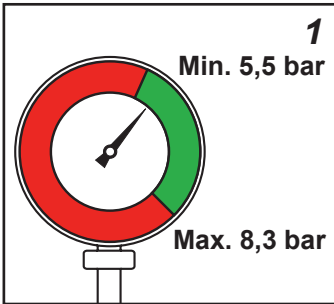



014 748

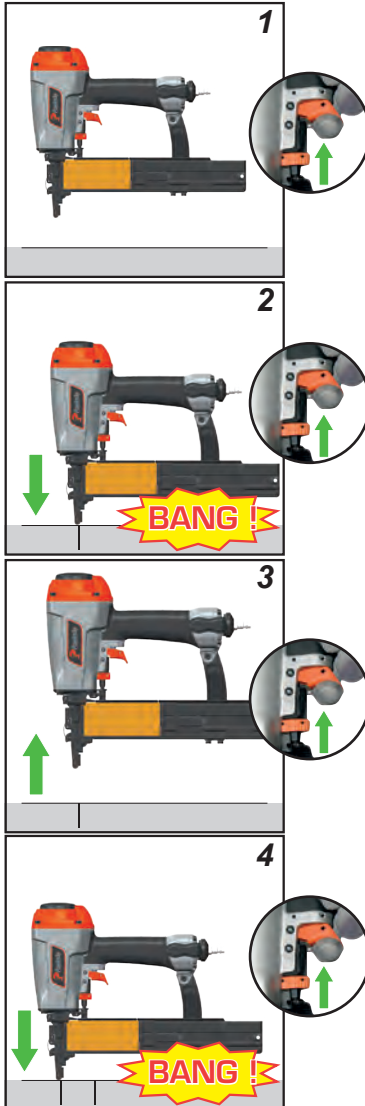

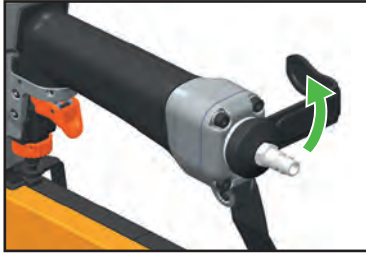
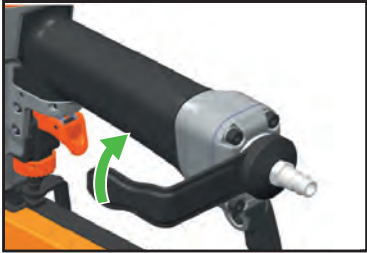
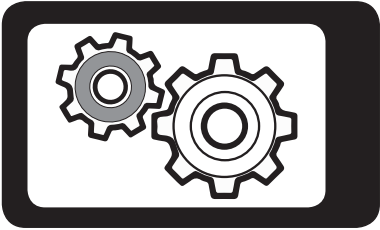

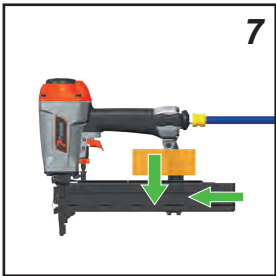
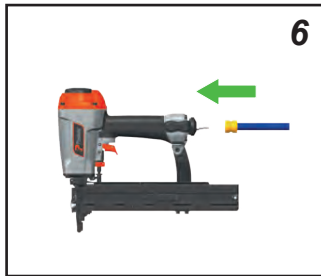
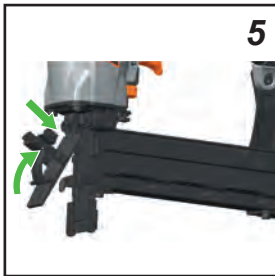
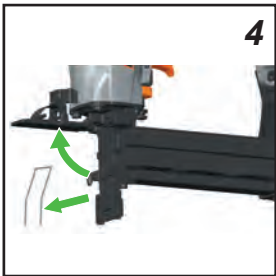
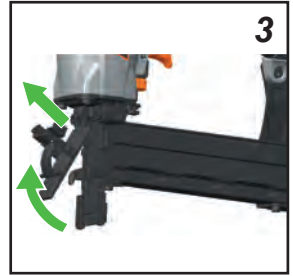
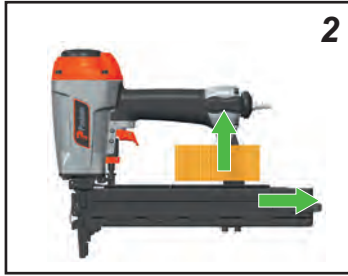
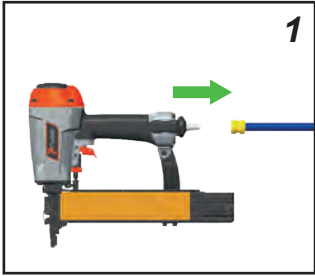
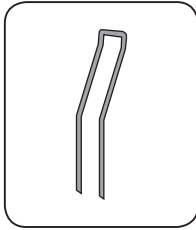

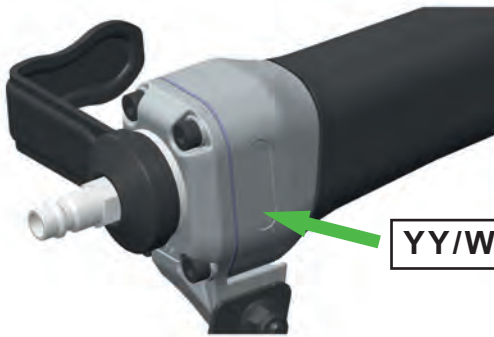

YY/WW....

YY= Year of manufacture
WW = Week of manufacture

**Resting position/ Ruheposition/ Position de repos/ Ruststand/
Posición de descanso/ Posizione di riposo/ Posição de des-
canso/ Pozycja spoczynku/ Klidová poloha/ Nyugalmi állapot/
Положение в нерабочем состоянии/ Θέση αδράνειας/ Hviles-
tilling/ Viloläge/ Hvileposisjon/ Lepoasento/ Položaj mirovanja/
Pokoјová poloha/ Položaj mirovanja/ وضع السكون / Ramybės
padėtis/ Ooteasend/ Miera stāvoklis/ Hvíldarstaða**





ITW CONSTRUCTION PRODUCTS EUROPE
Code 577063 (11/2019)
www.spitpaslode.com