

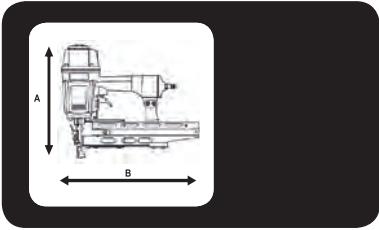

haubold®

PN765
PN7965





PN765



		A = 307 mm
		B = 380 mm
		C = 94 mm
		= 2,9 kg









<p>Min. 5,5 bar Max. 8,3 bar</p>
<p>1,9 l (6 bar) /</p>
<p>Ps max. = 8,3 bar</p>





<p>EN 12549+EN ISO 4871</p>	<p>L_{WA}, 1s, 1m = 102 dBA</p> <p>L_{pA}, 1s = 54 dBA</p> <p>L_{pA}, 1s, 1m = 89 dBA</p>
<p>EN 12096 : 1997</p> <p>ISO 8662 - 11</p>	<p>Vibration = 2,1 m/s²</p>

<p>140 x</p>	<p>KG700</p>	<p>B = 11,3 mm</p> <p>L = 32-65 mm</p> <p>d = 1,34 x 1,6 mm</p>
--------------	---------------------	--





	<p>Sequential trigger actuation/ Einzelauslösung/ enkelschots/ Déclenchement du tir - mode séquentiel/ Funcionamiento secuencial "en continuo"/ Gatilho de actuação sequencial/ funzionamento sequenziale (colpo a colpo)/ Enkeltskuds aftrækker/ Enkelskott/ Enkeltskudds avtrekker/ Kertalaukaisu/ Üksiklasu meetodil töötamine/ Uruchromienie spustu sekwencyjne/ Sekvenčni spoušť/ Egyes lövés (szakaszosan működtetett elsütő billentyűvel)/ Posamezno proženje/ Kontaktirajte singl / Последовательная активация при нажатии на курок/ Sekvenčná aktivácia spúšte/ التشغيل بالزر التسلسلي المقفول / Nuoseklusis paleidimo mechanizmas/ Sekvencialās palaides iedarbināšana Raðkveikjувirkjun</p>
	<p>Contact trigger actuation/ Kontaktauslösung/ repeterend schieten/ Déclenchement du tir - mode rafale/ Funcionamiento por contacto "clavo a clavo"/ Gatilho de actuação por contacto/ funcionamento a contatto/ Stødskydnings aftrækker/ Støtskjutning/ Støtspikrings avtrekker/ Kosketuslaukaisu/ Automaatmeetodil töötamine/ Uruchromienie spustu przez kontakt/ Kontaktní spoušť/ Sorozatlövés (folyamatosan behúzott elsütő billentyűvel)/ Kontaktno proženje/ Kontaktirajte prokretanje/ Контактная активация при нажатии на курок/ Kontaktná aktivácia spúšte/ التشغيل بتلامس الزر / Kontaktinis paleidimo mechanizmas/ Kontakta palaides iedarbināšana/ Snertikveikjувirkjun</p>

<p>Model: PN765 Sequential No. 574514</p>  <div data-bbox="302 558 533 710" style="border: 1px solid black; padding: 5px;"> <p>PN765 PNEUMATIC STAPLER Code : 574514 Trigger Actuation : Sequential STAPLE SPECIFICATION HAUBOLD K0700 SERIES</p>  <p>CE</p>  <p><small>TM Battersburgsysteme GmbH, D-30658 Hannover, Germany.</small></p>  </div>	<p>Model: PN765 Contact No. 574712</p>  <div data-bbox="756 558 987 710" style="border: 1px solid black; padding: 5px;"> <p>PN765 PNEUMATIC STAPLER Code : 574712 Trigger Actuation : Contact STAPLE SPECIFICATION HAUBOLD K0700 SERIES</p>  <p>CE</p>  <p><small>TM Battersburgsysteme GmbH, D-30658 Hannover, Germany.</small></p>  </div>
	

				 2x
No. 014748 + No. 574516		No. 014121		

Accessories

	
No. 151299 / No. 576216	
0,5 l oil / 1 l oil	

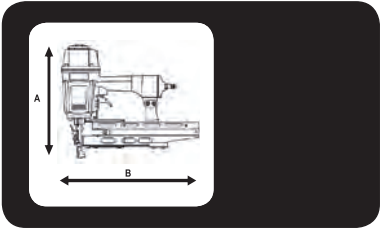

PN7965

		A = 307 mm B = 380 mm C = 94 mm



1,9 l (6 bar) /
Ps max. = 8,3 bar





	L_{WA}, 1s = 102 dBA L_{pA}, 1s = 54 dBA L_{pA}, 1s, 1M = 89 dBA
<small>EN 12549+EN ISO 4871</small> 	Vibration = 2,3 m/s²
<small>EN 12096 : 1997</small> <small>ISO 8662 - 11</small>	





130 x	
--------------	--

Haubold Staples HD7900	B = 11 mm L = 45-65 mm d = 1,6 x 1,89 mm



	<p>Sequential trigger actuation/ Einzelauslösung/ enkelschots/ Déclenchement du tir - mode séquentiel/ Funcionamiento secuencial "en continuo"/ Gatilho de actuação sequencial/ funzionamento sequenziale (colpo a colpo)/ Enkeltskuds aftrækker/ Enkelskott/ Enkeltskudds avtrekker/ Kertalaukaisu/ Üksiklasu meetodil töötamine/ Uruchromienie spustu sekwencyjne/ Sekvenčni spoušt/ Egyes lövés (szakaszosan működtetett elsütő billentyűvel)/ Posamezno proženje/ Kontaktirajte singl / Последовательная активация при нажатии на курок/ Sekvenčná aktivácia spúšte/ التشغيل بالزر التسلسلي المقيد / Nuoseklusis paleidimo mechanizmas/ Sekvencialās palaides iedarbināšana Račkveikjvirkjum</p>
	<p>Contact trigger actuation/ Kontaktauslösung/ repeterend schieten/ Déclenchement du tir - mode rafale/ Funcionamiento por contacto "clavo a clavo"/ Gatilho de actuação por contacto/ funcionamento a contatto/ Stødskydning's aftrækker/ Støtskjutning/ Støtspikrings avtrekker/ Kosketuslaukaisu/ Automaatmeetodil töötamine/ Uruchromienie spustu przez kontakt/ Kontaktní spoušt/ Sorozatlövés (folyamatosan behúzott elsütő billentyűvel)/ Kontaktno proženje/ Kontaktirajte rocketanje/ Контактная активация при нажатии на курок/ Kontaktná aktivácia spúšte/ التشغيل بتلامس الزر / Kontaktinis paleidimo mechanizmas/ Kontakta palaides iedarbināšana/ Sneritkveikjvirkjum</p>

<p>Model: PN7965 Sequential No. 574519</p>  <div data-bbox="307 569 535 718" style="border: 1px solid red; padding: 5px;"> <p>PN7965 PNEUMATIC STAPLER Code : 574519 Trigger Actuation : Sequential STAPLE SPECIFICATION HAUBOLD HD7900 SERIES</p>  <p style="text-align: right;">haubold</p> <p style="font-size: small;">ITW Beteiligungs-systeme GmbH, D-30868 Hannover, Germany</p> </div>	<p>Model: PN7965 Contact No. 574717</p>  <div data-bbox="752 561 981 710" style="border: 1px solid red; padding: 5px;"> <p>PN7965 PNEUMATIC STAPLER Code : 574517 Trigger Actuation : Contact STAPLE SPECIFICATION HAUBOLD HD7900 SERIES</p>  <p style="text-align: right;">haubold</p> <p style="font-size: small;">ITW Beteiligungs-systeme GmbH, D-30868 Hannover, Germany</p> </div>
	

			 2x
No. 014748 + No. 574516	No. 014121		

Accessories



No. 151299 / No. 576216
0,5 l oil / 1 l oil

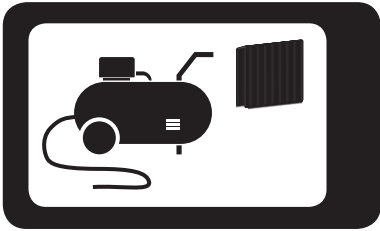

014 748

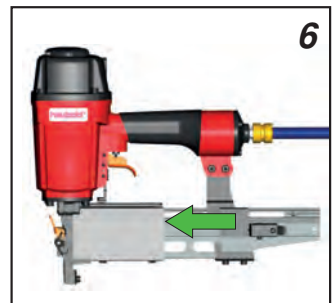
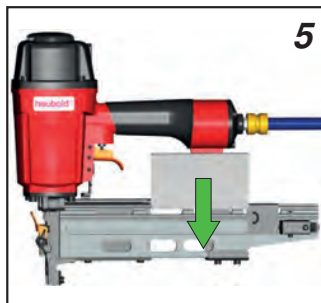
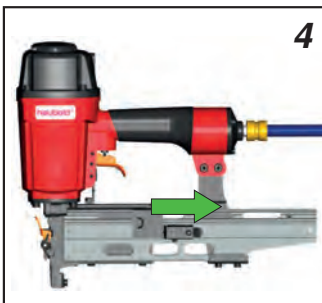
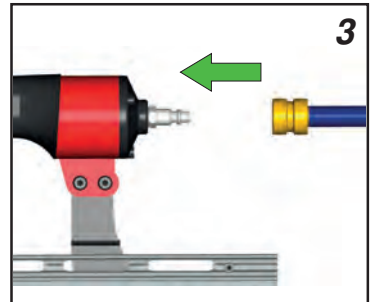
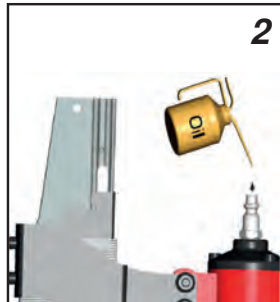
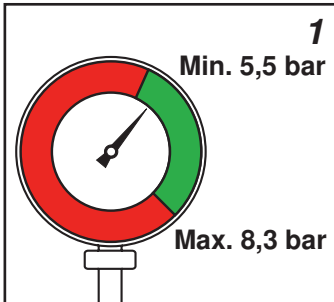

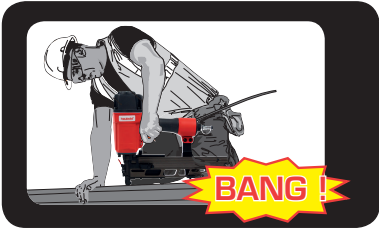

014 748

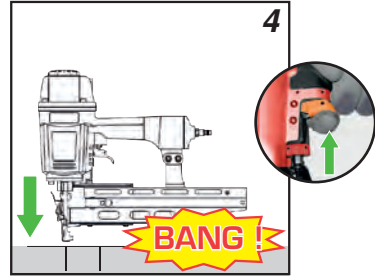
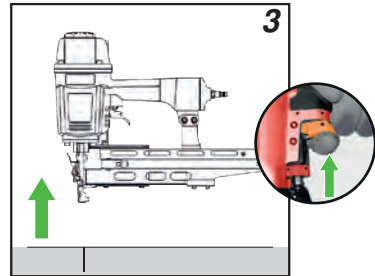
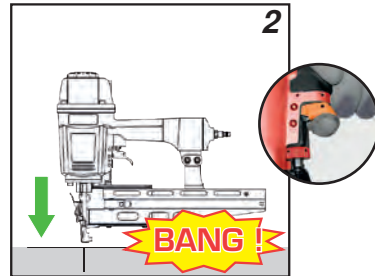
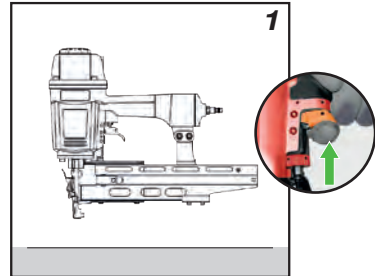
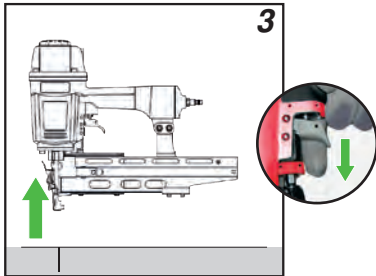
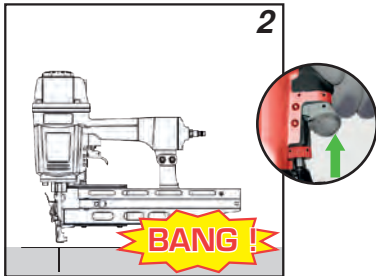
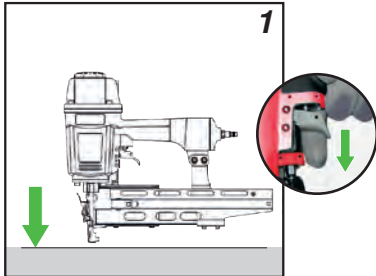

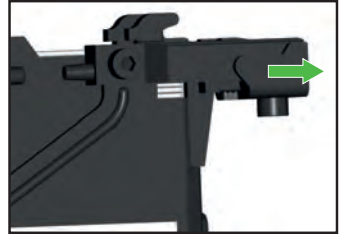
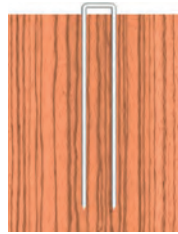
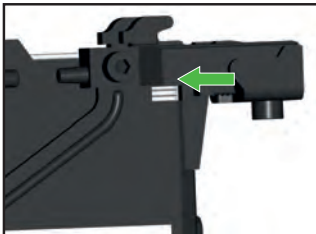
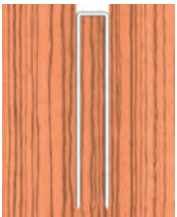
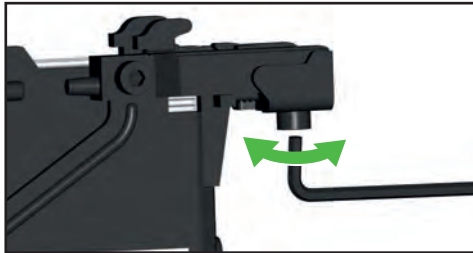
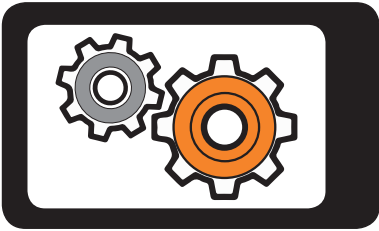

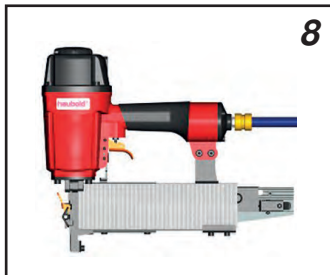
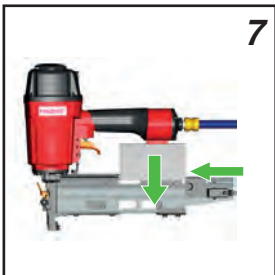
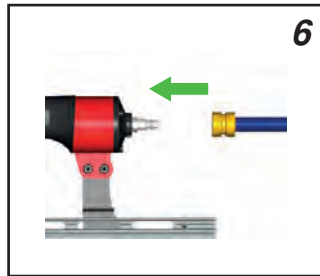
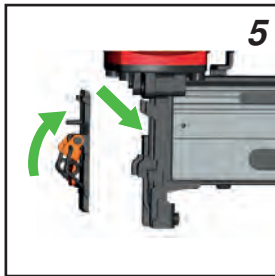
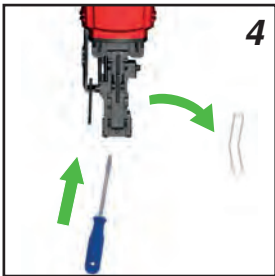
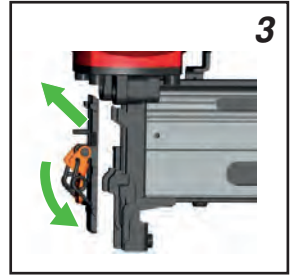
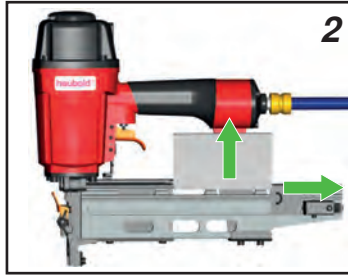
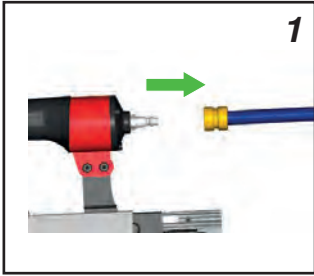
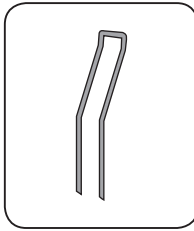



YY/WW....

YY= Year of manufacture
WW = Week of manufacture

**Resting position/ Ruheposition/ Position de repos/ Ruststand/
Posición de descanso/ Posizione di riposo/ Posição de des-
canso/ Pozycja spoczynku/ Klidová poloha/ Nyugalmi állapot/
Положение в нерабочем состоянии/ Θέση αδράνειας/ Hviles-
tilling/ Viloläge/ Hvileposisjon/ Leposento/ Položaj mirovanja/
Pokojová poloha/ Položaj mirovanja/ وضع السكون / Ramybės
padėtis/ Ooteasend/ Miera stāvoklis/ Hvíldarstaða**



haubold[®]

ITW CONSTRUCTION PRODUCTS EUROPE
Code 574516 (05/2019)
www.spitpaslode.com