



Paslode[®]
Impulse[®]

IM200/50 S16





Paslode
Impulse

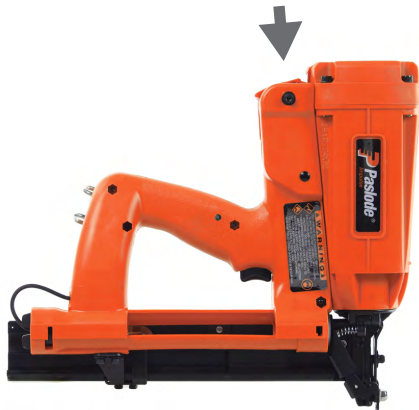

Paslode
Impulse



= 1000
(+5°C)

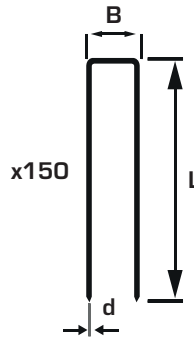

S16
B = 13 mm
L = 19 - 51 mm
d = 1,6 x 1,4 mm

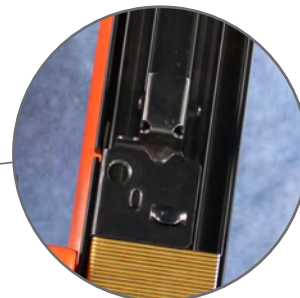
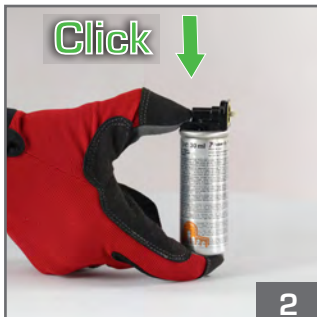

Paslode
Impulse

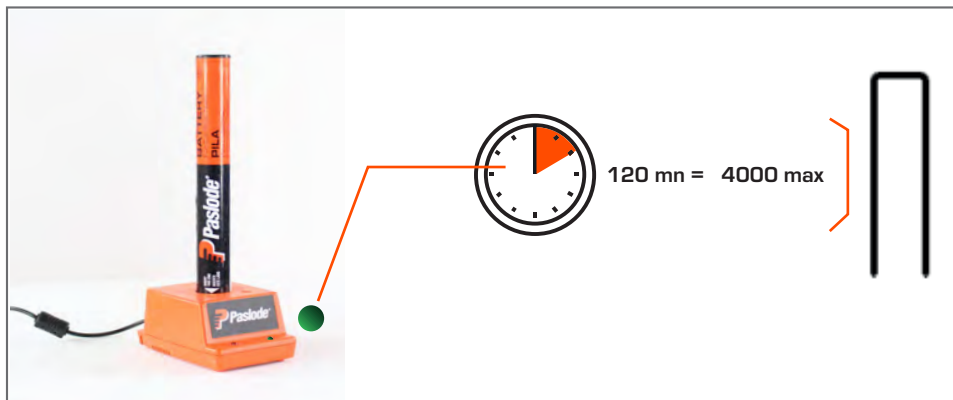
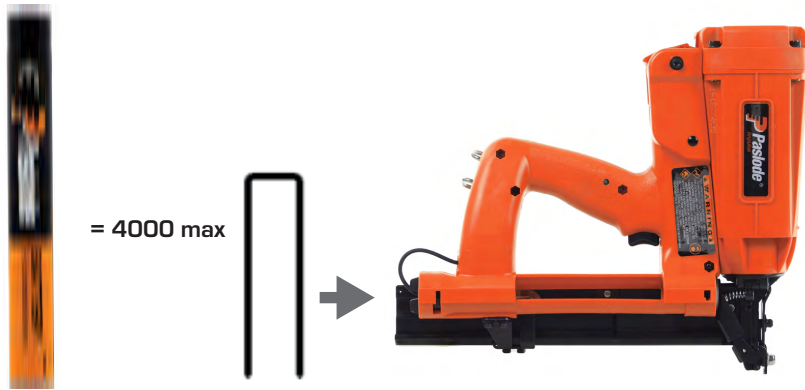



BANG!



+5°C → +49°C

500/hour



1



2



3



4

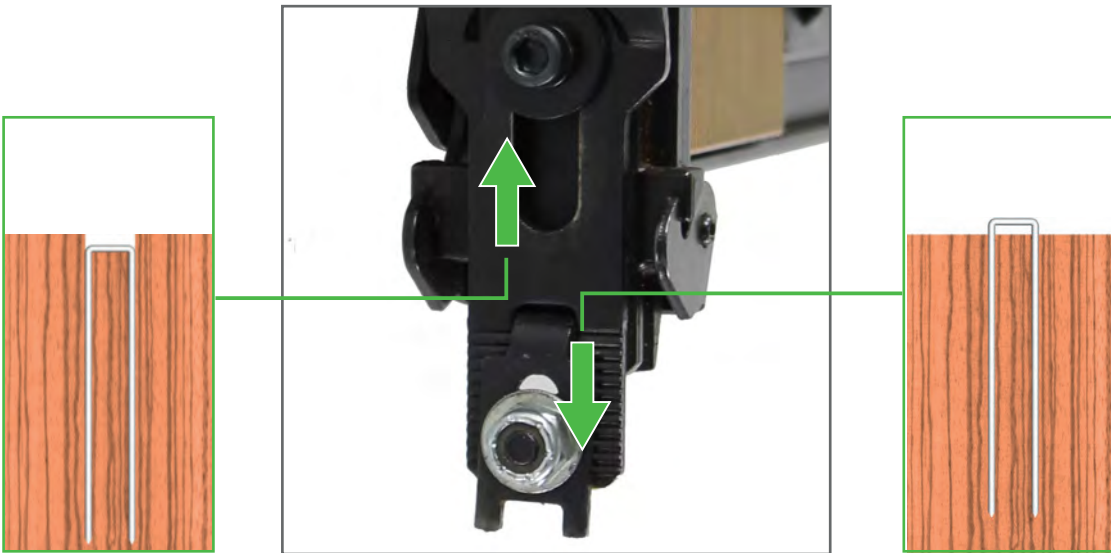

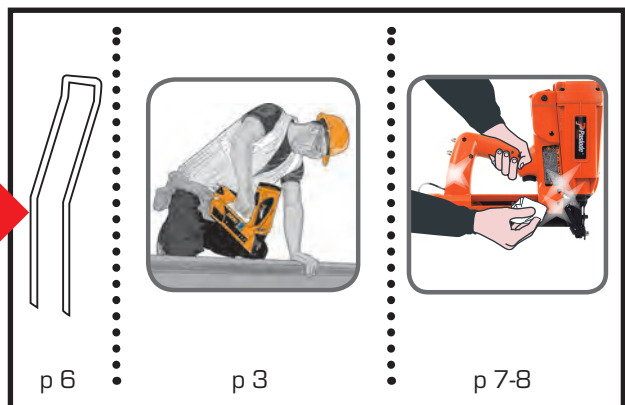
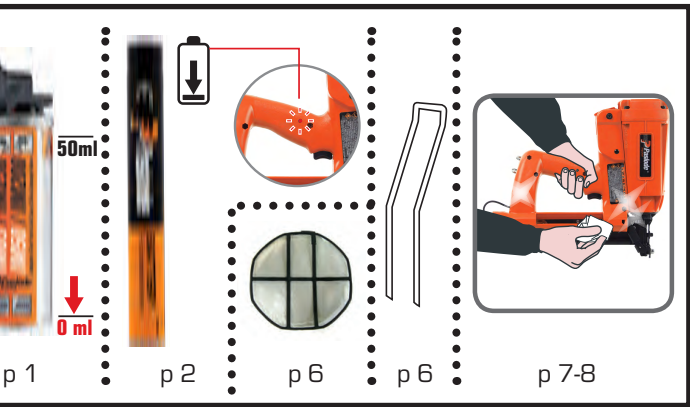
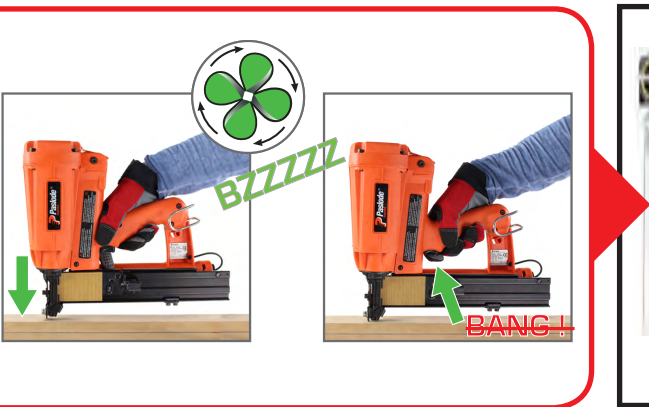
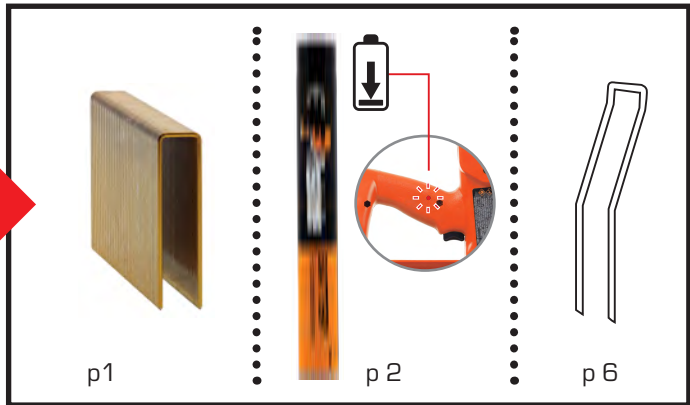

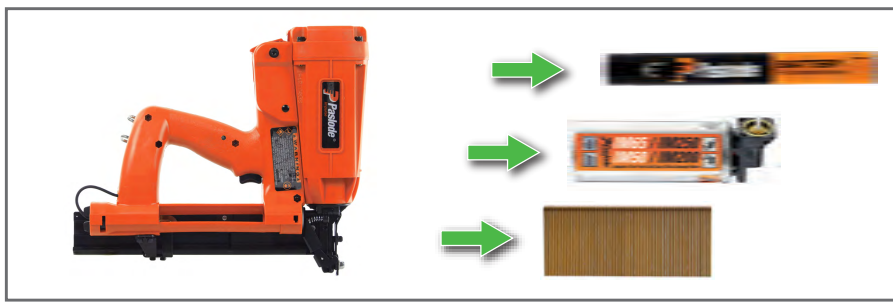
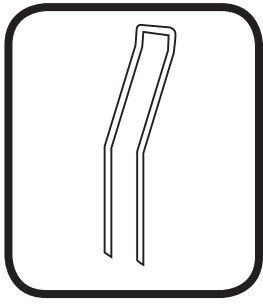

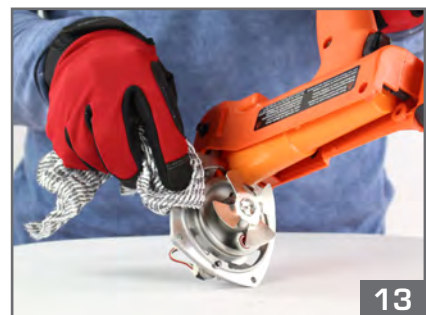
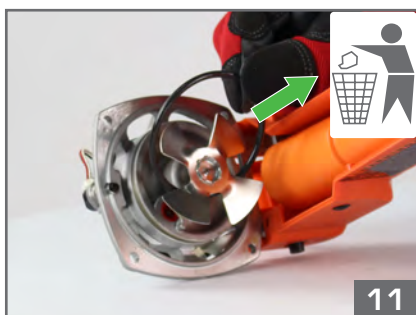
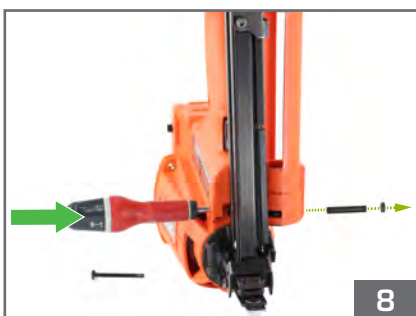
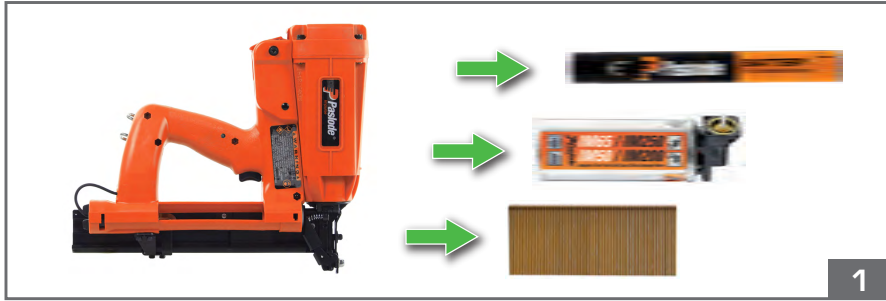

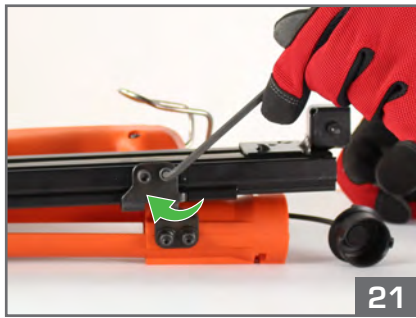
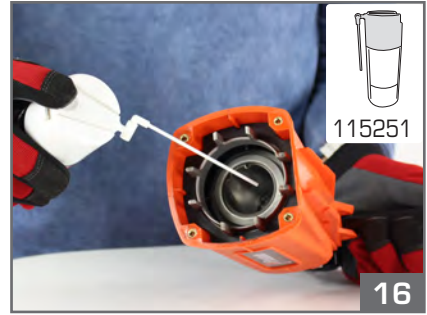

Resting position/ Ruheposition/ Position de repos/ Ruststand/ Posición de descanso/ Posizione di riposo/ Posição de descanso/ Pozycja spoczynku/ Klidová poloha/ Nyugalmi állapot/ Положение в нерабочем состоянии/ Θέση αδράνειας/ Hviletilling/ Viloläge/ Hvileposisjon/ Lepoasento/ Položaj mirovanja/ Pokojová poloha/ Položaj mirovanja/ وضع السكون / Ramybės padėtis/ Ooteasend/ Miera stāvoklis/ Hvíldarstaða



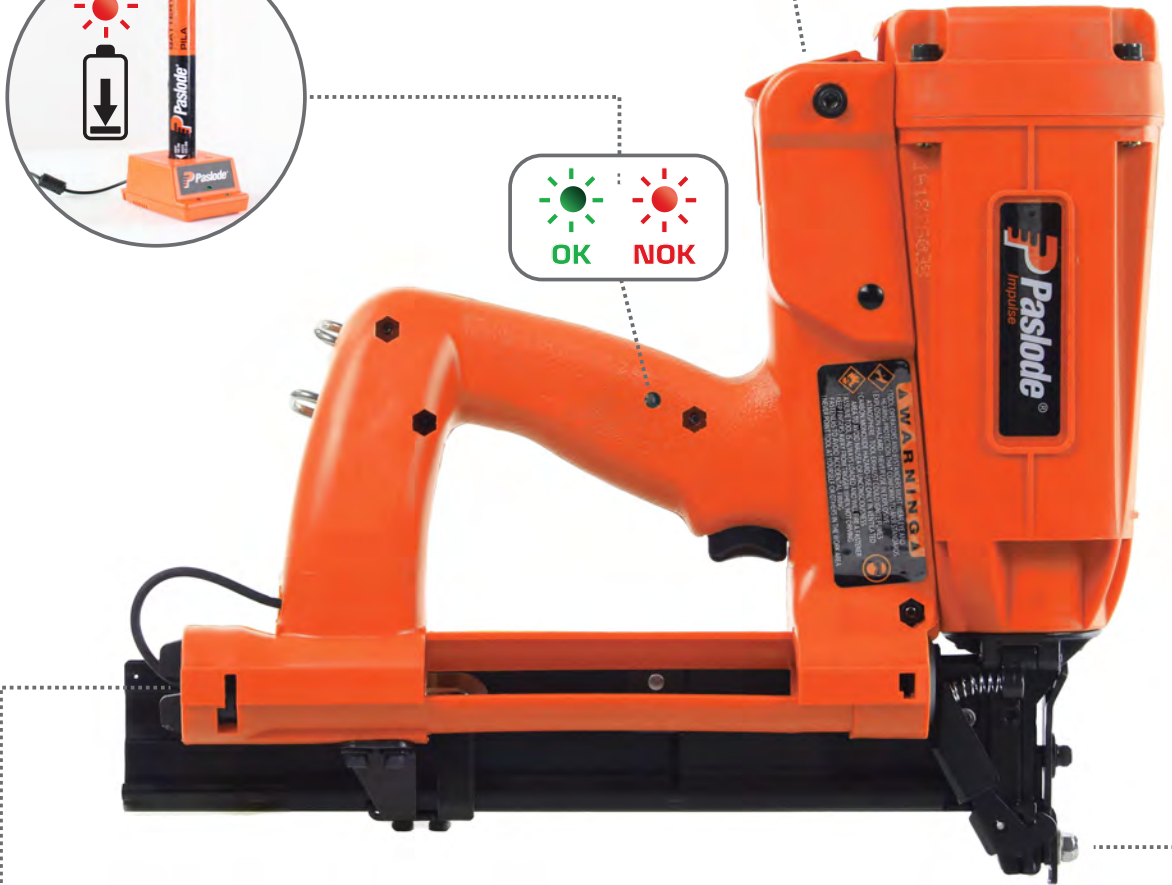
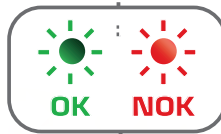
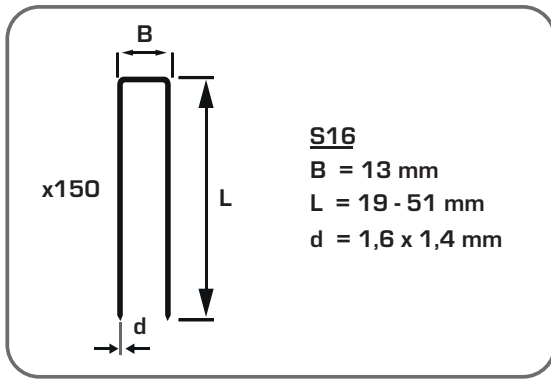

Route de Lyon
 F-26500 Bourg-lès-Valence
 FRANCE

Réalisation Made in France - Photos non contractuelles