

Deformation-controlled expansion female anchor for use in non-cracked concrete



ETA Option 7- 05/0053



GRIP & GRIP L
M10/M12

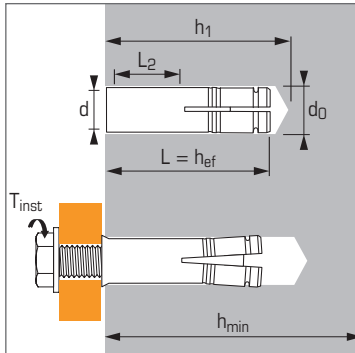

Technical data

Anchor size	Min. anchor depth	Thread diameter	Thread length	Drilling depth	Drilling diameter	Min. thick. of base material	Total anchor length	Tighten torque	Code without collar version	Code collar version	Setting tool reference	Setting tool code
	(mm) hef	(mm) d	(mm) L₂	(mm) h₀	(mm) d₀	(mm) h_{min}	(mm) L	(Nm) T_{inst}				
M6X30	30	6	13	32	8	100	30	5	062040	050789	ST-M M6x30	050922
M7X30*	30	7	13	33	10	100	30	10	061980	-	ST-M M7x30	050932
M8X30	30	8	12	33	10	100	30	10	062050	050790	ST-M M8x30	050923
M10X30	30	10	11	33	12	100	30	22	-	050799	ST-M M10x30	051015
M10X40	40	10	15	43	12	100	40	22	062060	050791	ST-M M10x40	050924
M12X50	50	12	21	54	15	100	50	36	062070	050792	ST-M M12x50	050925
M16X65	65	16	28	70	20	130	65	80	062080	050793	ST-M M16x65	050926

* Do not belong to ETA

APPLICATION

- Ventilation ducts
- Suspended ceilings
- Cable trays

MATERIAL

- **Sleeve** : steel, 11 SMnPb30
- **Expansion cone**: Fb10, NF A 35-053
- **Protection** : galvanised 5 µm min.

INSTALLATION

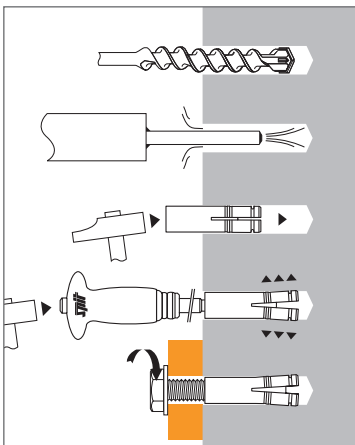

Anchor mechanical properties

Anchor size	M6	M8	M10	M12	M16
f_{uk} (N/mm ²) Min. tensile strength	570	570	570	570	550
f_{yk} (N/mm ²) Yield strength	420	375	375	345	345
As (mm ²) Stressed cross-section	26,34	36,22	47,15	80	138,74

GRIP & GRIP L

2/4 zinc coated steel version

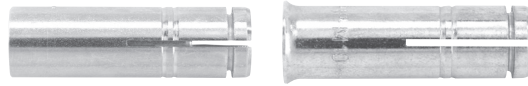

The loads specified on this page allow judging the product's performances, but cannot be used for the designing. The data given in the pages "CC method" have to be applied (3/4 and 4/4).

Ultimate ($N_{Ru,m}$, $V_{Ru,m}$) and characteristic loads (N_{Rk} , V_{Rk}) in kN

Mean Ultimate loads are derived from test results in admissible service conditions, and characteristic loads are statistically determined.

TENSILE

Anchor size	M6	M8	M10	M10	M12	M16
Screw grade 8.8						
$h_{ef,min}$	30	30	30	40	50	65
$N_{Ru,m}$	10,5	13,4	14,9	18,4	31,2	37,1
N_{Rk}	8,5	9,4	8,5	14,5	26,2	29,8

SHEAR

Anchor size	M6	M8	M10	M12	M16
Screw grade 8.8					
$V_{Ru,m}$	9	14,8	22,3	27,1	58,3
V_{Rk}	4,5	8,7	13,2	14,8	45,8

Design loads (N_{Rd} , V_{Rd}) for one anchor without edge or spacing influence in kN

$$N_{Rd} = \frac{N_{Rk}^*}{\gamma_{Mc}}$$

*Derived from test results

$$V_{Rd} = \frac{V_{Rk}^*}{\gamma_{Ms}}$$

TENSILE

Anchor size	M6	M8	M10	M10	M12	M16
Screw grade 8.8						
$h_{ef,min}$	30	30	30	40	50	65
N_{Rd}	4,7	5,2	4,7	8,1	14,6	16,6

$\gamma_{Mc} = 1,8$

SHEAR

Anchor size	M6	M8	M10	M12	M16
Screw grade 8.8					
V_{Rd}	3,3	5,7	8,7	9,0	28,8

$\gamma_{Ms} = 1,25$

Recommended loads (N_{rec} , V_{rec}) for one anchor without edge or spacing influence in kN

$$N_{rec} = \frac{N_{Rk}^*}{\gamma_M \cdot \gamma_F}$$

*Derived from test results

$$V_{rec} = \frac{V_{Rk}^*}{\gamma_M \cdot \gamma_F}$$

TENSILE

Anchor size	M6	M8	M10	M10	M12	M16
Screw grade 8.8						
$h_{ef,min}$	30	30	30	40	50	65
N_{rec}	3,4	3,7	3,4	5,8	10,4	11,8

$\gamma_F = 1,4$; $\gamma_{Mc} = 1,8$

SHEAR

Anchor size	M6	M8	M10	M12	M16
Screw grade 8.8					
V_{rec}	2,4	4,1	6,2	6,4	20,6

$\gamma_F = 1,4$; $\gamma_{Ms} = 1,25$

Recommended loads (N_{rec} , V_{rec}) in beam slab in kN

	Hollow concrete slab TYPE DSL 20* (wall thickness: 25 mm)			Hollow concrete slab TYPE DSL 27* (wall thickness : 30 mm)			
	N_{rec}	V_{rec}		N_{rec}		V_{rec}	
Min. steel quality of screw	5.6	5.6	8.8	5.6	8.8	5.6	8.8
GRIP L M6X30	2,10	1,25	2,00	2,50	2,70	1,25	2,20
GRIP L M8X30	2,10	2,30	3,10	2,70	2,70	2,30	3,10
GRIP L M10X30	2,10	3,60	4,60	2,70	2,70	3,60	4,60

* kp1 trade mark (supplier for hollow concrete slab)

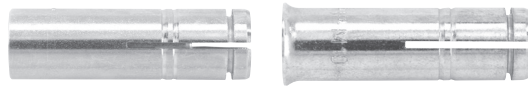

SPIT CC Method (values issued from ETA)

TENSILE in kN

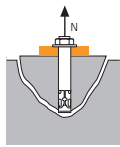

Concrete cone resistance

$$N_{Rd,c} = N_{Rd,c}^0 \cdot f_b \cdot \Psi_s \cdot \Psi_{c,N}$$

$N_{Rd,c}^0$	Design cone resistance					
Anchor size	M6	M8	M10	M10	M12	M16
h_{ef}	30	30	30	40	50	65
$N_{Rd,c}^0$ (C20/25)	4,6	4,6	4,6	7,1	9,9	14,7

$$\gamma_{Mc} = 1,8$$

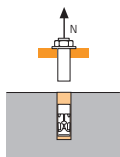

Steel resistance

$N_{Rd,s}$	Steel design tensile resistance					
Anchor size	M6	M8	M10	M10	M12	M16
Screw grade 4.6						
$N_{Rd,s}$	4,0	7,3	11,6	11,6	16,9	31,4
Screw grade 5.6						
$N_{Rd,s}$	5,1	9,2	14,5	14,5	21,1	39,3
Screw grade 5.8						
$N_{Rd,s}$	6,7	11,3	14,8	14,8	23,0	39,9
Screw grade 8.8						
$N_{Rd,s}$	9,2	11,3	14,8	14,8	23,0	39,9

$$\gamma_{Ms} = 2 \text{ for screw grade 4.6 and 5.6}$$

$$1,5 < \gamma_{Ms} < 1,98 \text{ for screw grade 5.8 and 8.8 (cf. ETA)}$$

SHEAR in kN

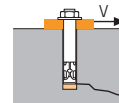

Concrete edge resistance

$$V_{Rd,c} = V_{Rd,c}^0 \cdot f_b \cdot f_{\beta,V} \cdot \Psi_{S,C,V}$$

$V_{Rd,c}^0$	Design concrete edge resistance at minimum edge distance (C_{min})					
Anchor size	M6	M8	M10	M10	M12	M16
h_{ef}	30	30	30	40	50	65
C_{min}	105	105	140	140	195	227
S_{min}	60	70	80	95	125	130
$V_{Rd,c}^0$ (C20/25)	8,3	8,9	14,5	15,3	28,1	40,5

$$\gamma_{Mc} = 1,5$$

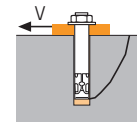

Pryout failure

$$V_{Rd,cp} = V_{Rd,cp}^0 \cdot f_b \cdot \Psi_s \cdot \Psi_{c,N}$$

$V_{Rd,cp}^0$	Design pryout resistance					
Anchor size	M6	M8	M10	M10	M12	M16
h_{ef}	30	30	30	40	50	65
$V_{Rd,cp}^0$ (C20/25)	5,5	5,5	5,5	8,5	11,9	35,2

$$\gamma_{Mcp} = 1,5$$

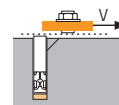

Steel resistance

$V_{Rd,s}$	Steel design shear resistance					
Anchor size	M6	M8	M10	M10	M12	M16
Screw grade 4.6						
$V_{Rd,s}$	2,4	4,4	6,9	6,9	10,1	18,8
Screw grade 5.6						
$V_{Rd,s}$	3,0	5,5	8,7	8,7	12,6	23,5
Screw grade > 5.8						
$V_{Rd,s}$	3,1	6,8	8,8	8,8	13,8	24,0

$$\gamma_{Ms} = 1,67 \text{ for screw grade 4.6 and 5.6}$$

$$1,36 < \gamma_{Ms} < 1,65 \text{ for screw grade 5.8 (cf. ETA)}$$

$$N_{Rd} = \min(N_{Rd,p}; N_{Rd,c}; N_{Rd,s})$$

$$\beta_N = N_{Sd} / N_{Rd} \leq 1$$

$$V_{Rd} = \min(V_{Rd,c}; V_{Rd,cp}; V_{Rd,s})$$

$$\beta_V = V_{Sd} / V_{Rd} \leq 1$$

$$\beta_N + \beta_V \leq 1,2$$

f_b INFLUENCE OF CONCRETE

Concrete class	f_b	Concrete class	f_b
C25/30	1,1	C40/50	1,41
C30/37	1,22	C45/55	1,48
C35/45	1,34	C50/60	1,55

$f_{\beta,V}$ INFLUENCE OF SHEAR LOADING DIRECTION

Angle β [°]	$f_{\beta,V}$
0 to 55	1
60	1,1
70	1,2
80	1,5
90 to 180	2

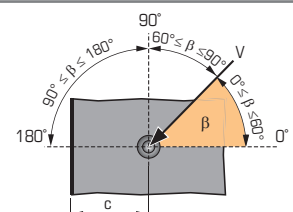



SPIT CC Method (values issued from ETA)

Ψ_s INFLUENCE OF SPACING FOR CONCRETE CONE RESISTANCE IN TENSILE LOAD

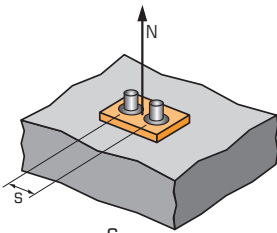

$$\Psi_s = 0,5 + \frac{s}{6 \cdot h_{ef}}$$

$$s_{min} < s < s_{cr,N}$$

$$s_{cr,N} = 3 \cdot h_{ef}$$

Ψ_s must be used for each spacing influenced the anchors group

SPACING S	Reduction factor Ψ_s Non-cracked concrete						
	Anchor size	M6	M8	M10	M10	M12	M16
h_{ef}	30	30	30	40	50	65	
60	0,83						
70	0,89	0,89					
80	0,94	0,94	0,94				
95	1,00	1,00	1,00	0,90			
110				0,96			
125				1,00	0,92		
130					0,93	0,83	
150					1,00	0,88	
180						0,96	
195						1,00	

$\Psi_{c,N}$ INFLUENCE OF EDGE FOR CONCRETE CONE RESISTANCE IN TENSILE LOAD

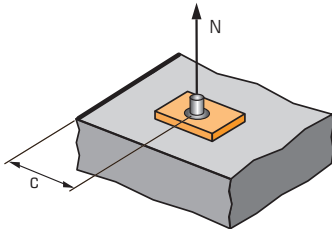

$$\Psi_{c,N} \leq 1$$

$$c \geq c_{min}$$

$\Psi_{c,N}$ must be used for each distance influenced the anchors group.

EDGE C	Reduction factor $\Psi_{c,N}$ Non-cracked concrete						
	Anchor size	M6	M8	M10	M10	M12	M16
h_{ef}	30	30	30	40	50	65	
105	1,00	1,00					
140			1,00	1,00			
195					1,00		
227						1,00	

$\Psi_{s-c,V}$ INFLUENCE OF SPACING AND EDGE DISTANCE FOR CONCRETE EDGE RESISTANCE IN SHEAR LOAD

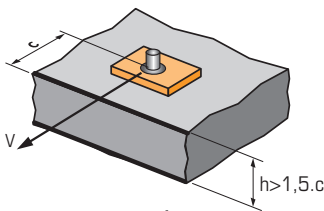

$$\Psi_{s-c,V} = \frac{c}{c_{min}} \cdot \sqrt{\frac{c}{c_{min}}}$$

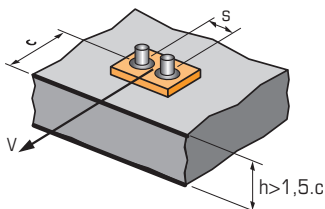

$$\Psi_{s-c,V} = \frac{3 \cdot c + s}{6 \cdot c_{min}} \cdot \sqrt{\frac{c}{c_{min}}}$$

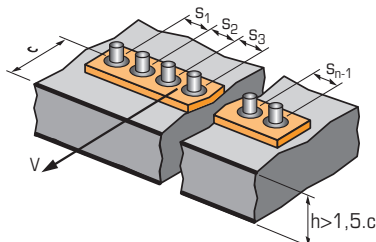

For single anchor fastening

$\frac{c}{c_{min}}$	Reduction factor $\Psi_{s-c,V}$ Non-cracked concrete											
	1,0	1,2	1,4	1,6	1,8	2,0	2,2	2,4	2,6	2,8	3,0	3,2
$\Psi_{s-c,V}$	1,00	1,31	1,66	2,02	2,41	2,83	3,26	3,72	4,19	4,69	5,20	5,72

For 2 anchors fastening

$\frac{s}{c_{min}}$	$\frac{c}{c_{min}}$	Reduction factor $\Psi_{s-c,V}$ Non-cracked concrete											
		1,0	1,2	1,4	1,6	1,8	2,0	2,2	2,4	2,6	2,8	3,0	3,2
1,0	0,67	0,84	1,03	1,22	1,43	1,65	1,88	2,12	2,36	2,62	2,89	3,16	
1,5	0,75	0,93	1,12	1,33	1,54	1,77	2,00	2,25	2,50	2,76	3,03	3,31	
2,0	0,83	1,02	1,22	1,43	1,65	1,89	2,12	2,38	2,63	2,90	3,18	3,46	
2,5	0,92	1,11	1,32	1,54	1,77	2,00	2,25	2,50	2,77	3,04	3,32	3,61	
3,0	1,00	1,20	1,42	1,64	1,88	2,12	2,37	2,63	2,90	3,18	3,46	3,76	
3,5		1,30	1,52	1,75	1,99	2,24	2,50	2,76	3,04	3,32	3,61	3,91	
4,0			1,62	1,86	2,10	2,36	2,62	2,89	3,17	3,46	3,75	4,05	
4,5				1,96	2,21	2,47	2,74	3,02	3,31	3,60	3,90	4,20	
5,0					2,33	2,59	2,87	3,15	3,44	3,74	4,04	4,35	
5,5						2,71	2,99	3,28	3,71	4,02	4,33	4,65	
6,0							2,83	3,11	3,41	3,71	4,02	4,33	

For 3 anchors fastening and more

$$\Psi_{s-c,V} = \frac{3 \cdot c + s_1 + s_2 + s_3 + \dots + s_{n-1}}{3 \cdot n \cdot c_{min}} \cdot \sqrt{\frac{c}{c_{min}}}$$